

ureel

QUICKDRY 

HI DESIGN MEA 2019

A close-up photograph showing a cross-section of a mattress. The top layer is a thick, yellow, porous foam. Below it is a white, fibrous fabric layer. The mattress is resting on a light-colored wooden floor. The text 'QUICKDRY Q' is overlaid in the top left corner, and the slogan 'The inside that's Unbeatable outside' is overlaid in the bottom right corner.

QUICKDRY 

**The inside that's
Unbeatable outside**

THE REASONS FOR QUICKDRY

1. COMFORT
2. IN-BUILT ANTI-MICROBIAL
3. DURABILITY
4. 5 YEARS WARRANTY
5. ENVIRONMENTLY FRIENDLY



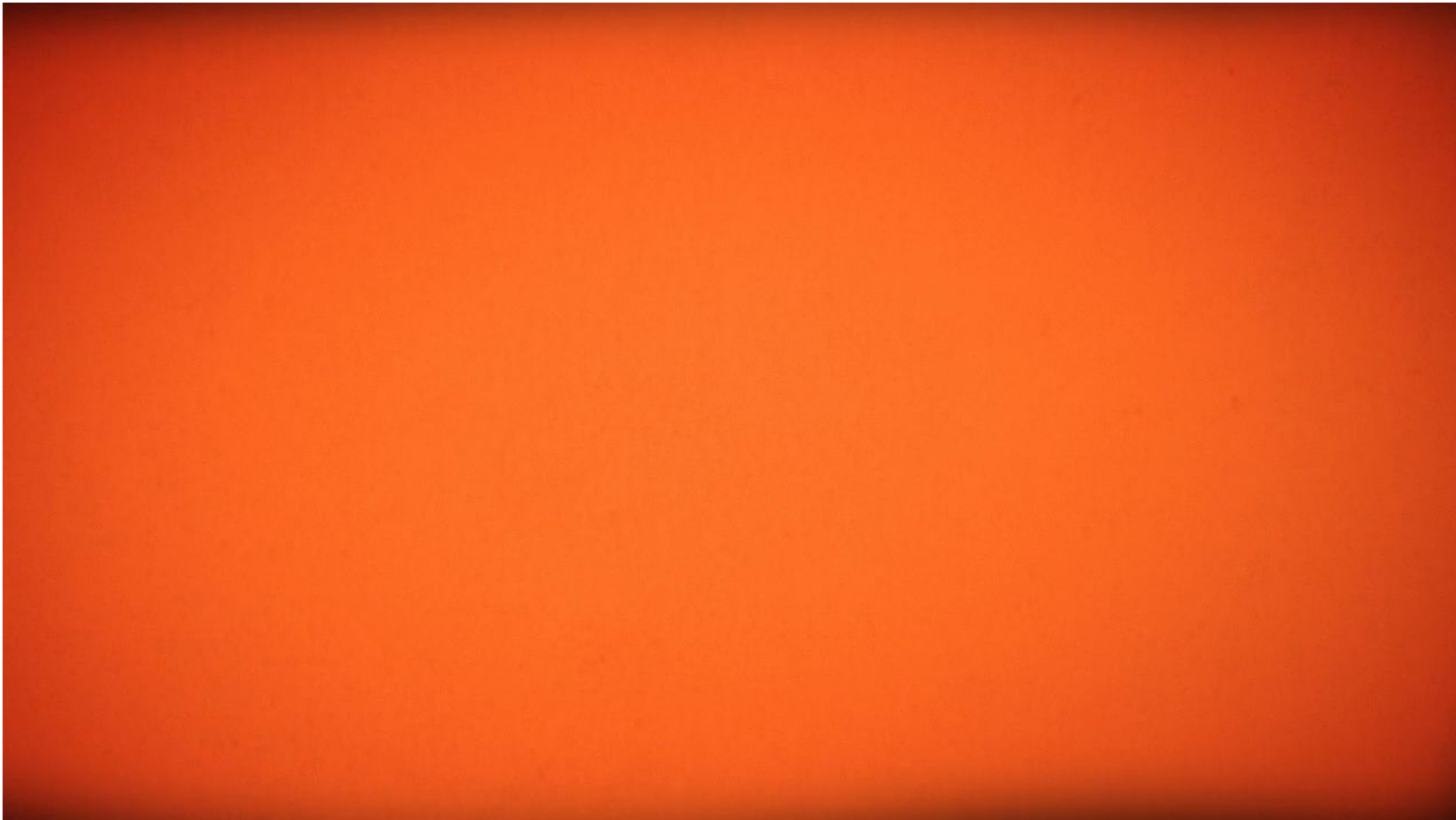

01 COMFORT

- Breathability with using solution dyed acrylic fabrics without waterproof lining
- 4 Different Hardness fine tuning comfort depending on thickness and furniture

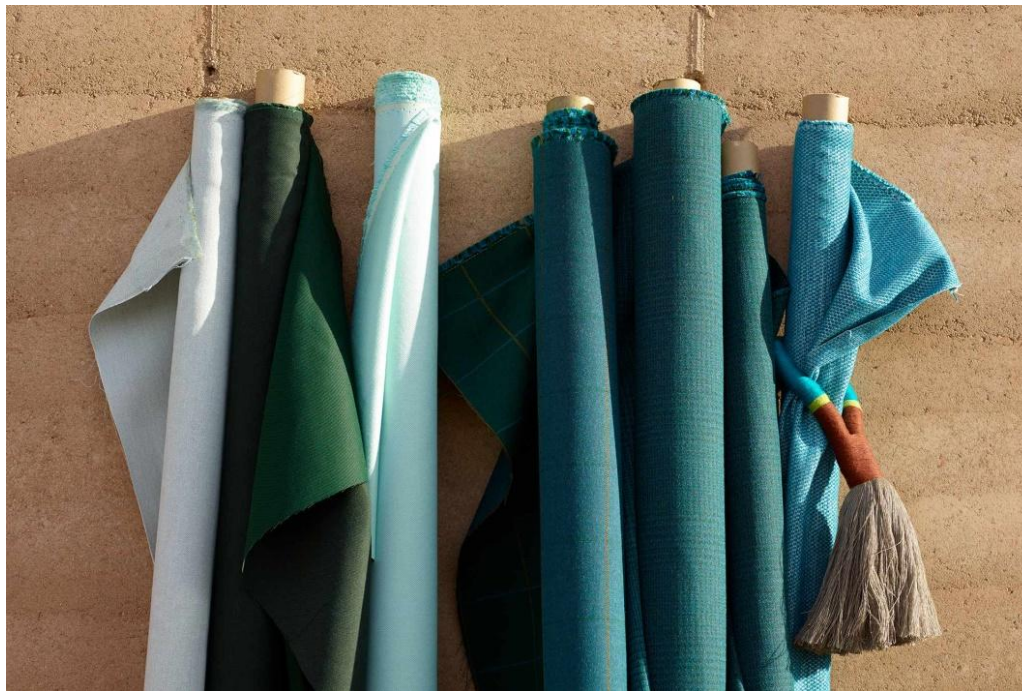

FIRM

MEDIUM

SOFT

SUPER
SOFT

02 IN-BUILT ANTI MICROBIAL

- Against mildew and fungus for further problems with bad odour



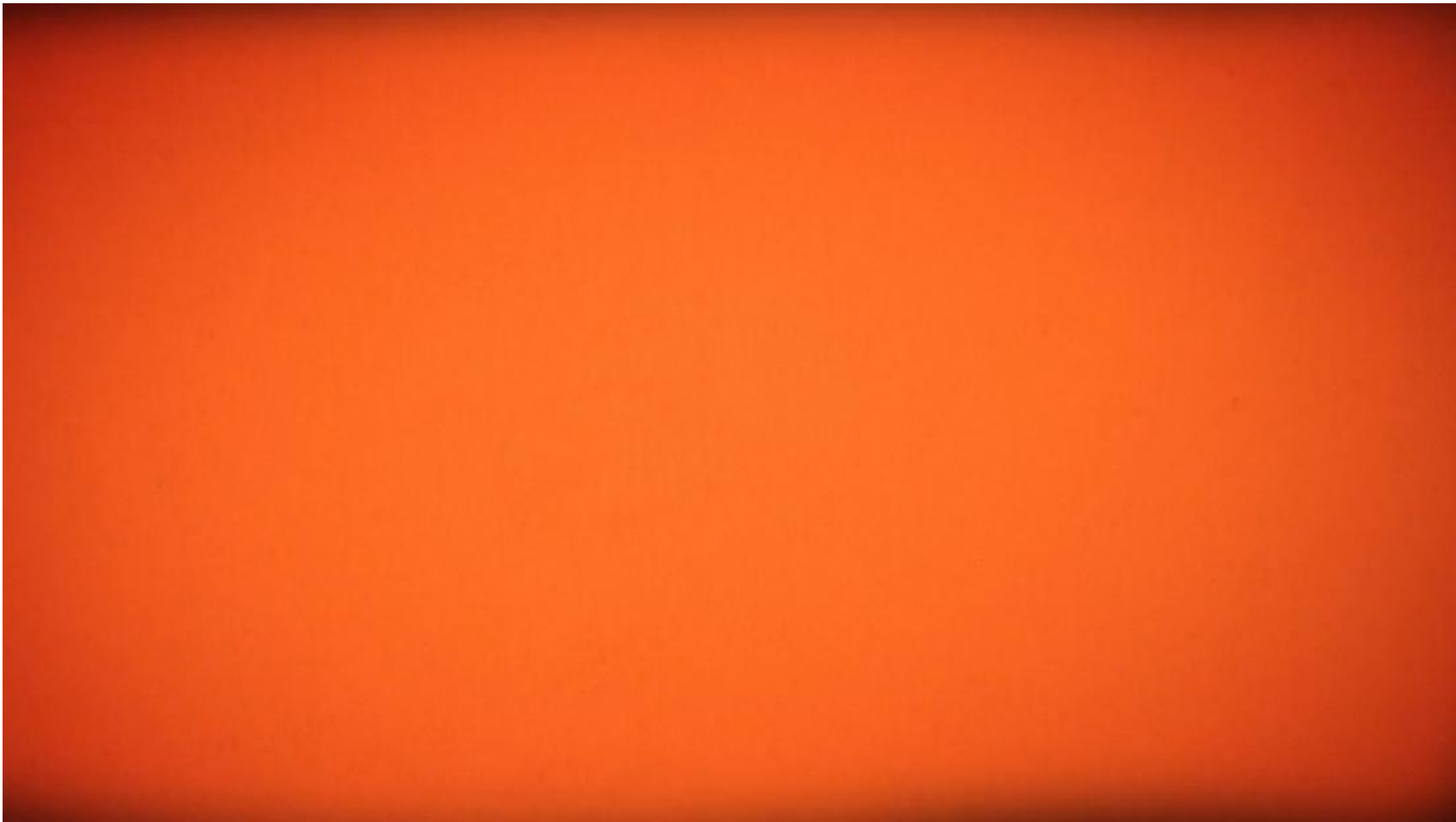

03 DURABILITY

- 120.000 stress cycle only make < 5% reduction in volume

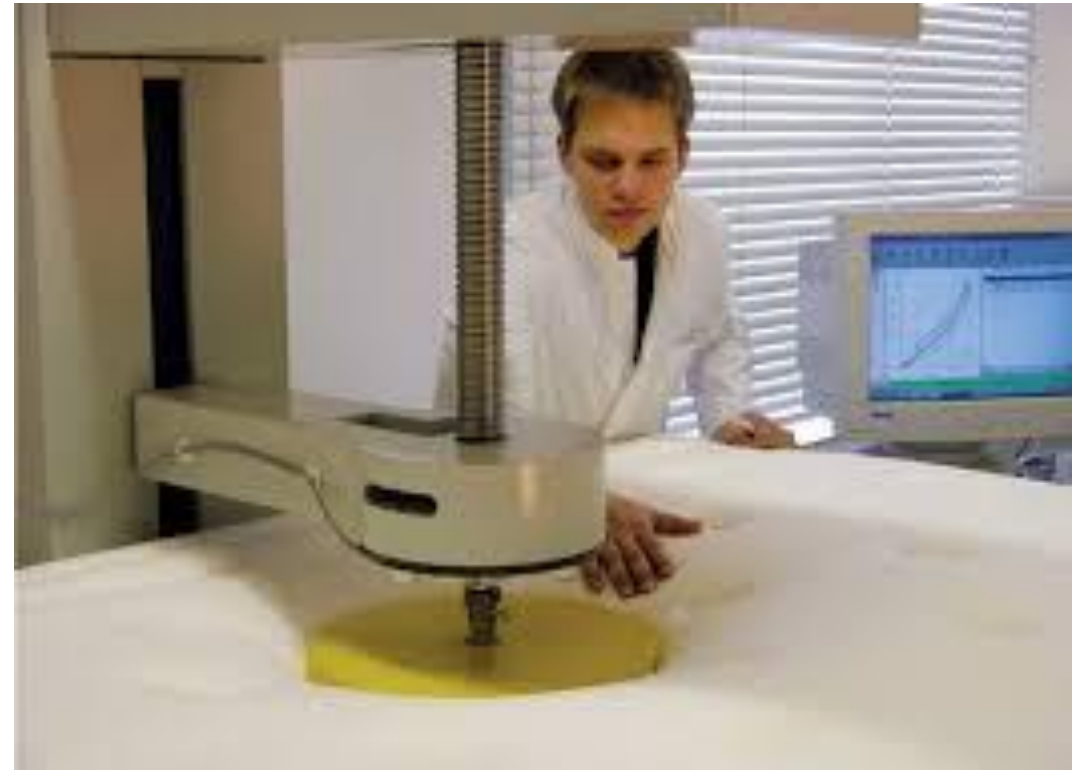
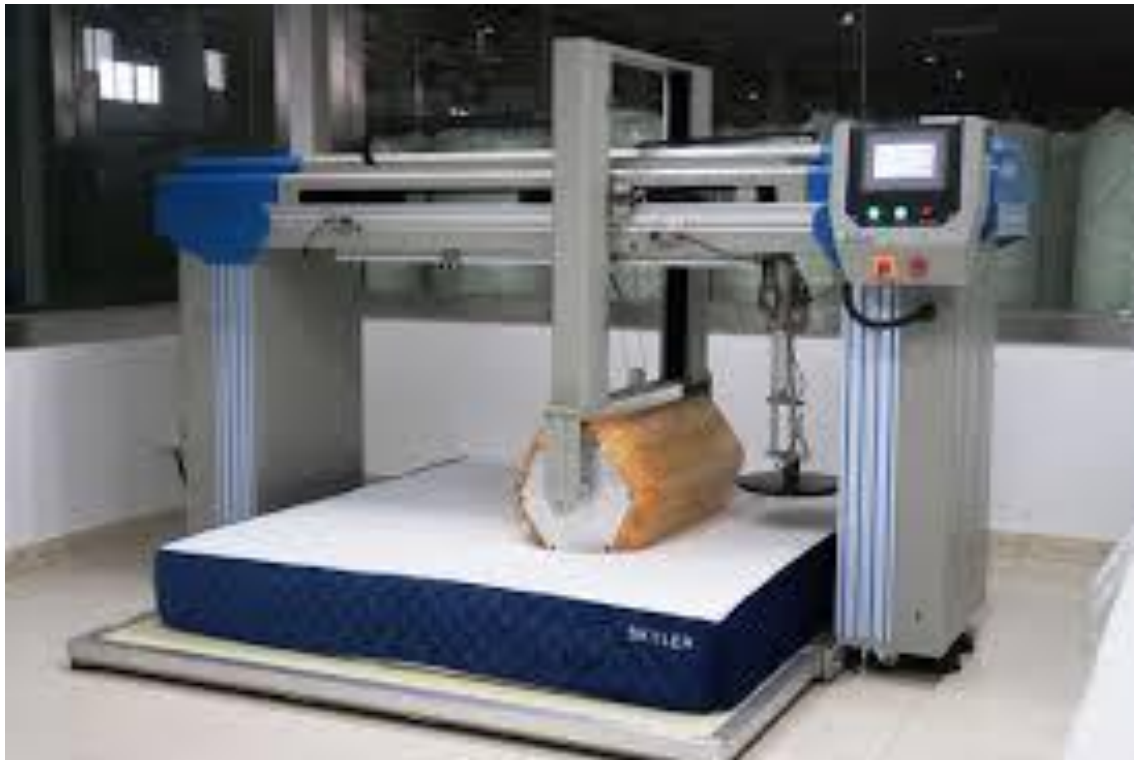

04

5 YEARS WARRANTY

We are only outdoor foam with warranty on the market



LIMITED WARRANTY



05

ENVIRONMENTLY FRIENDLY

- Environment friendly because with wrong choice material can make worst performance and make cushion
- Dacron were made from PET Bottle -> Global Recycle Standart Certification



Plastic
Container bin



Used PET
Bottle

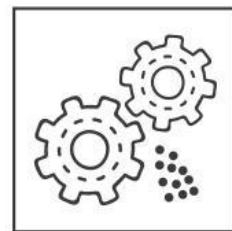

Selection and
grinding

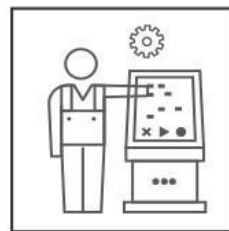

Production
line

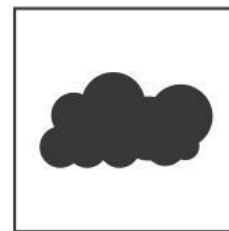

Polyster staple
fiber





- **INNOVATION**
- **TEAMWORK**
- **CREATION**

The Urecel story began in Korea in 1997 with the establishment of a specialised foam production line including the region's first Hydro Blast Reticulation unit, brought in from Germany.

Urecel has become the leading manufacturer of technical foam products to the automotive and electronics industries. Urecel is the first choice of top-end designers because it's simply the best there is.

4:34

LADER BERG
VÄRMLER
VÄRMEKÄMNER
VÄRMEPUMPAR



06

WHY QUICKDRY IS NO 1 IN THE WORLD?

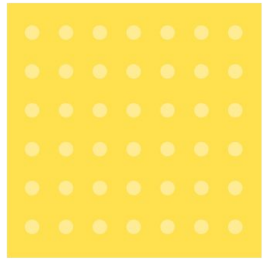

QuikDry Foam®



Mold forming on normal foam

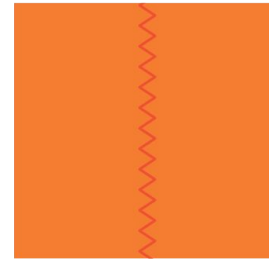

Water and air/humidity (through seam)

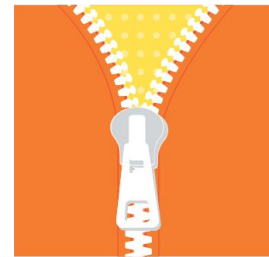

Water and air/humidity (through zipper)

- Core of outdoor performance cushion
- Humidity and rain cause condensation hence rotting
- Breathability is the key not water proofing
- Minimise the maintenance for house keeping
- Long-lasting durability and comfort
- Saving budget in long-term



THOUGHTTEST FOAM IN THE WORLD

HIGH GRADE MATERIAL

Carefully selected high grade material combine with our unique process to create a reticulated foam with **extreme durability and strength.**

ENVIRONMENTAL FRIENDLY

Urecel QuickDry Foam with **no VOC (Volatile Organic Compounds)** very safe for daily use dan eco friendly.

CAPABILITIES

- Our customers and business are international.
- To meet the high expectations our our clients, we source best in class machinery and experts from around the world.

QUICKDRY

- **Top leader 14 years**
- **German technology**
- **We are leading serving the top end outdoor furniture company**

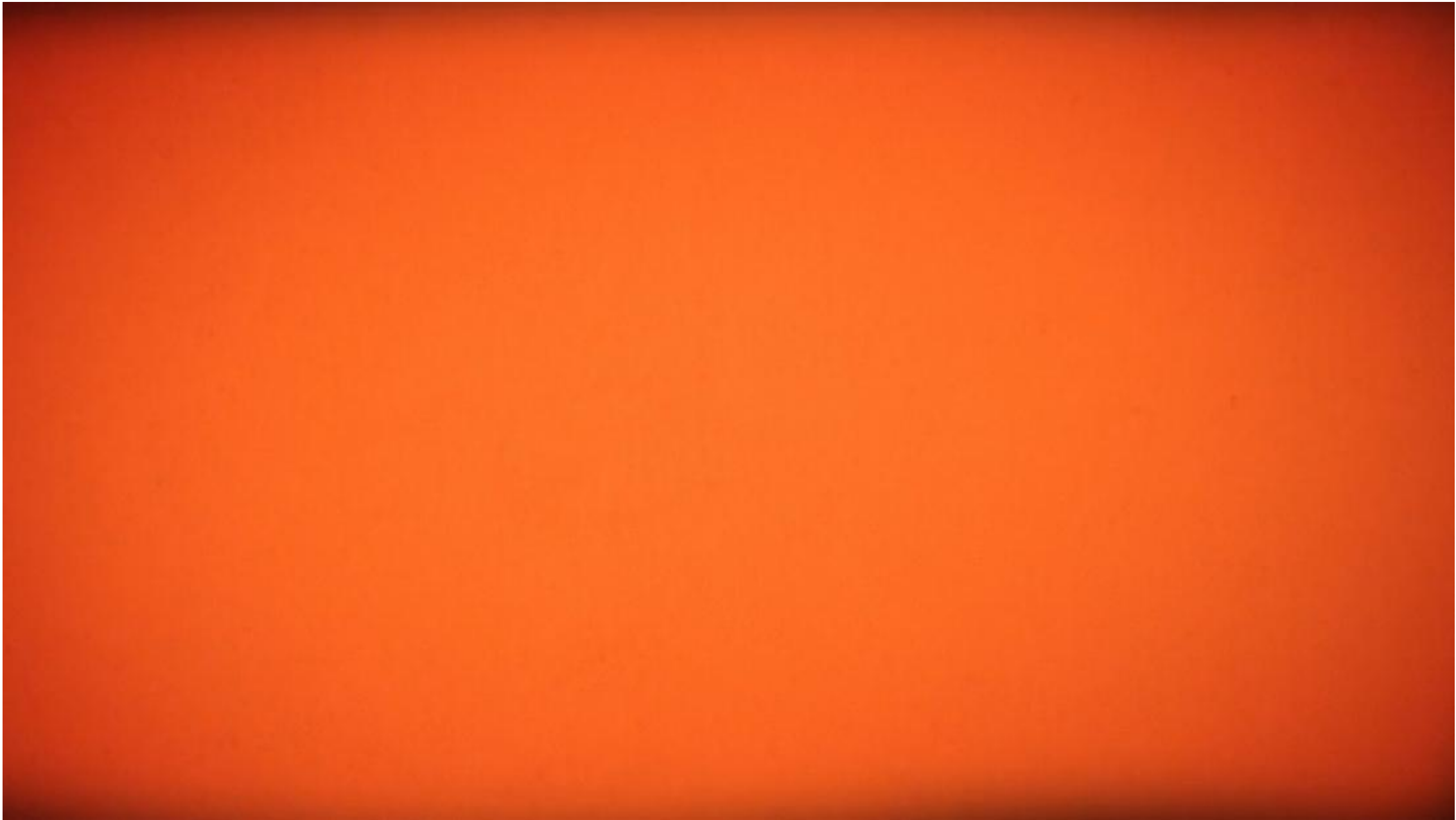

QuickDry is famous for outdoor furniture manufacture like

MANUTTI
Belgian outdoor furniture®

 GLOSTER

40

JANUS et Cie®

HOLLY HUNT

WHAT'S INSIDE THE CUSHION

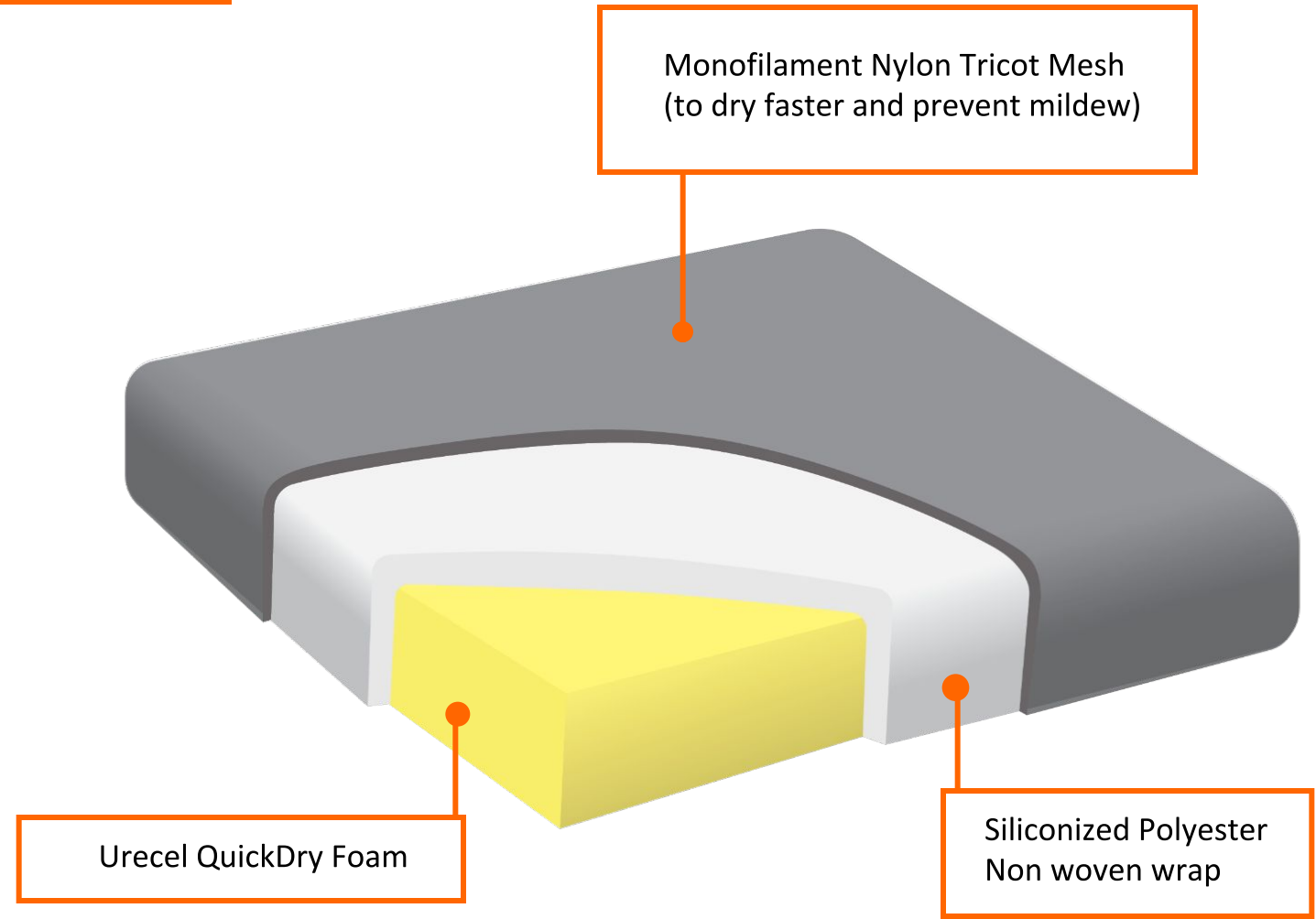

CUSHION CONSTRUCTION

Cushion cover (Top View)

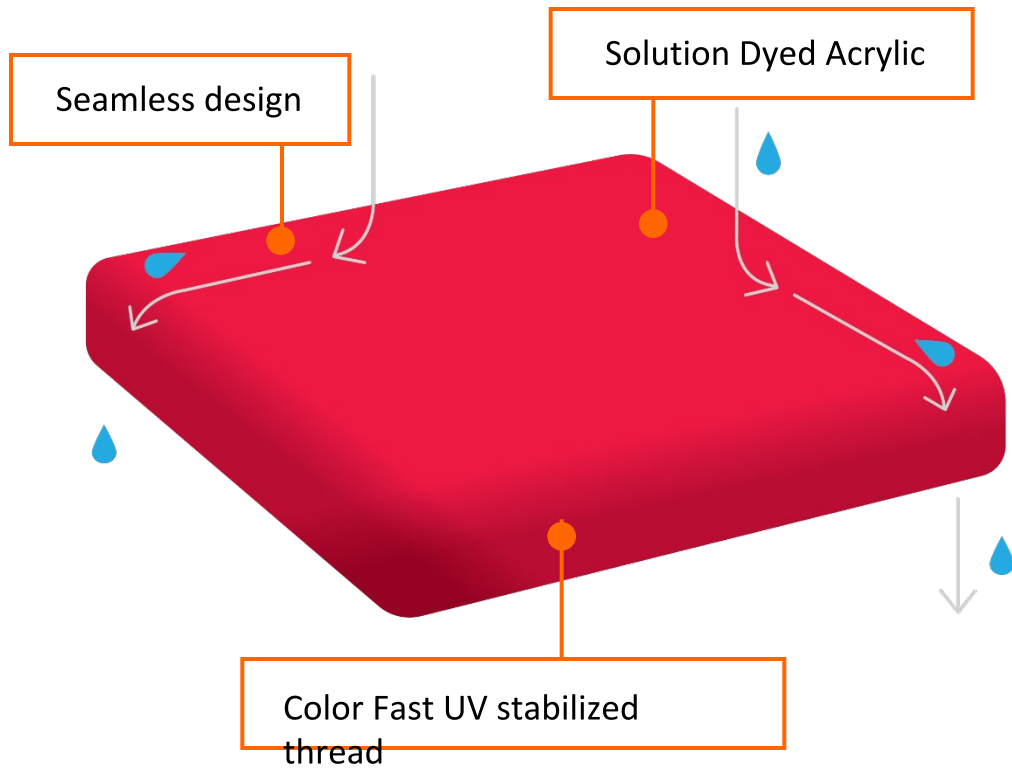

Cushion cover (Bottom View)

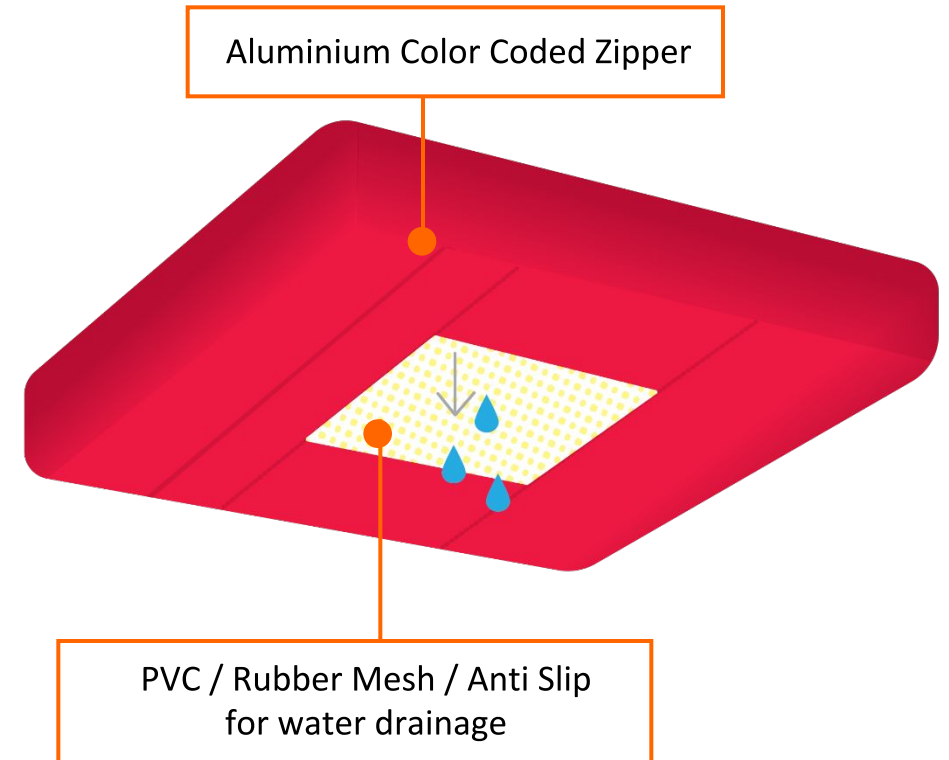

CUSHION CONSTRUCTION

Back Cushion

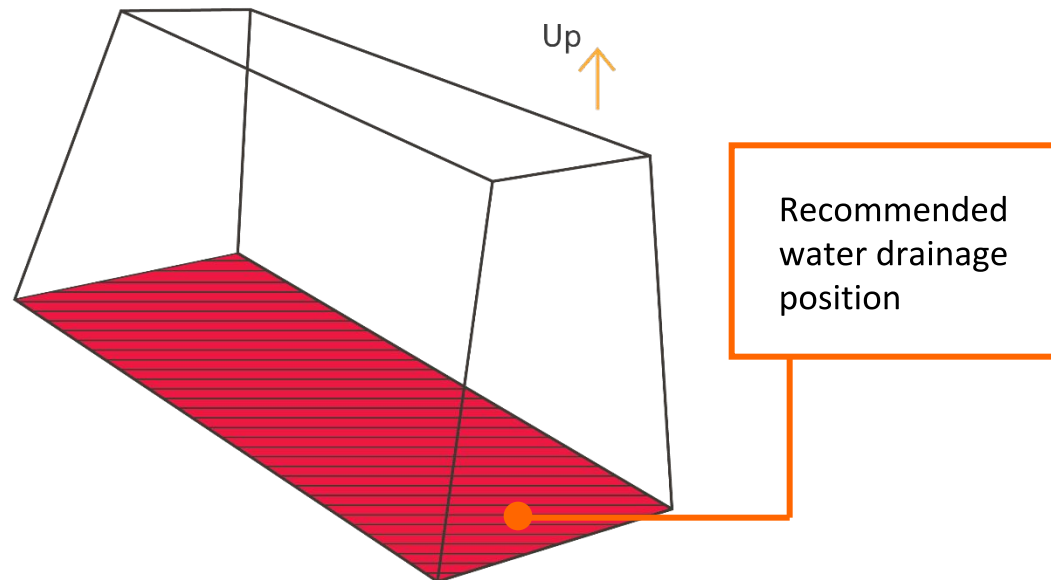

Seat Cushion

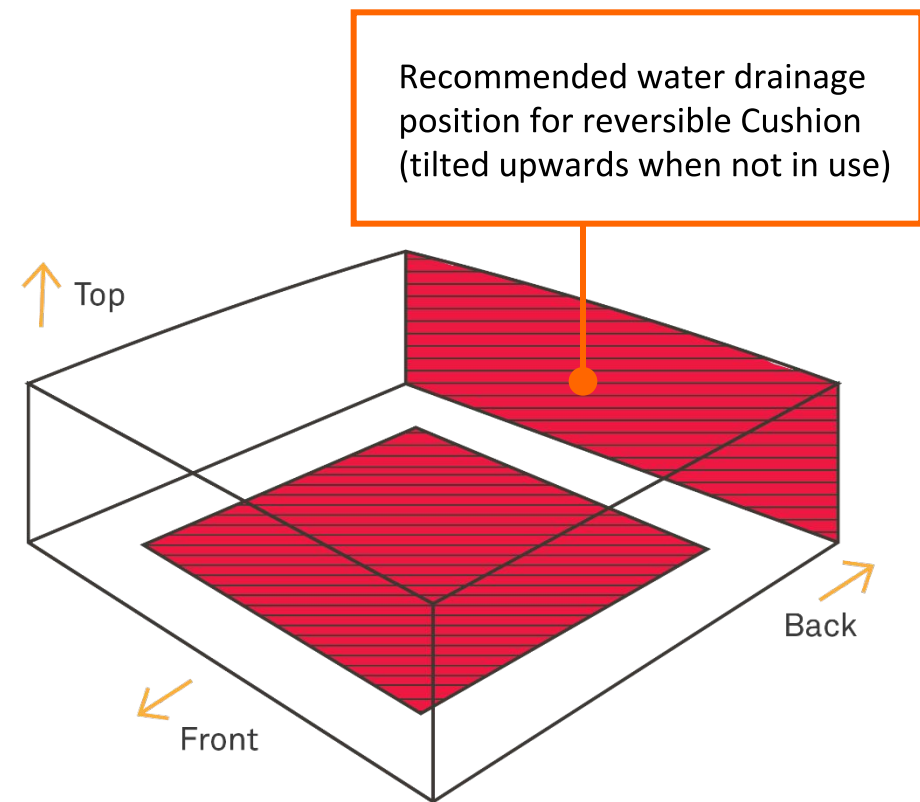

THICKNESS AND HARDNESS SEAT CUSHION LEVEL RECOMENDATION

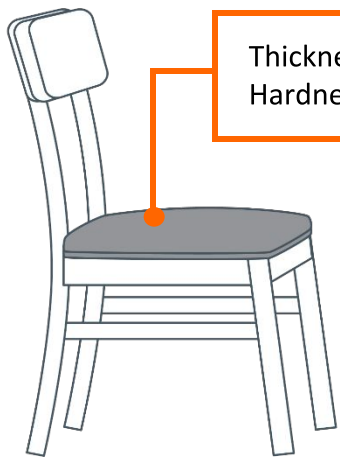

Thickness : 3- 6 cm
Hardness : Firm

Dining Chair

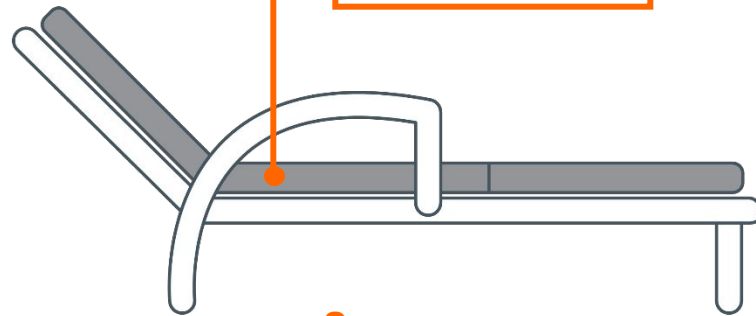

Thickness : 4- 6 cm
Hardness : Firm

Thickness : 7- 8 cm
Hardness : Medium

Sun Lounger

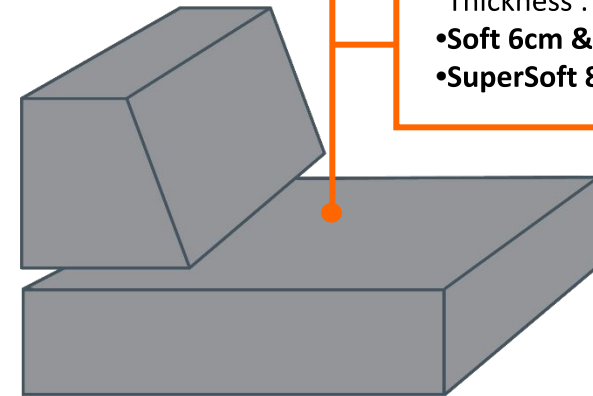

Thickness : 10 cm
•Soft 3cm & Medium 7cm
•SuperSoft 4cm & Firm 6cm

Thickness : 12 cm
•Soft 4cm & Medium 8cm
•SuperSoft 5cm & Firm 7cm

Thickness : 15 cm
•Soft 5cm & Medium 10cm
•Soft 7cm & Firm 8cm

Thickness : 18 cm
•Soft 6cm & Medium 12cm
•SuperSoft 8cm & Firm 10cm

Day Bed / Sofa

QUICKDRY 

PROJECT REFERENCE

Urecel QuickDry in7oceans Design



Urecel QuickDry in Hollyhunt Design



Urecel QuickDry in Kempinski Bahrain



Urecel QuickDry in Hollyhunt Design



Urecel QuickDry in Maldives



Urecel QuickDry in Alila Bali

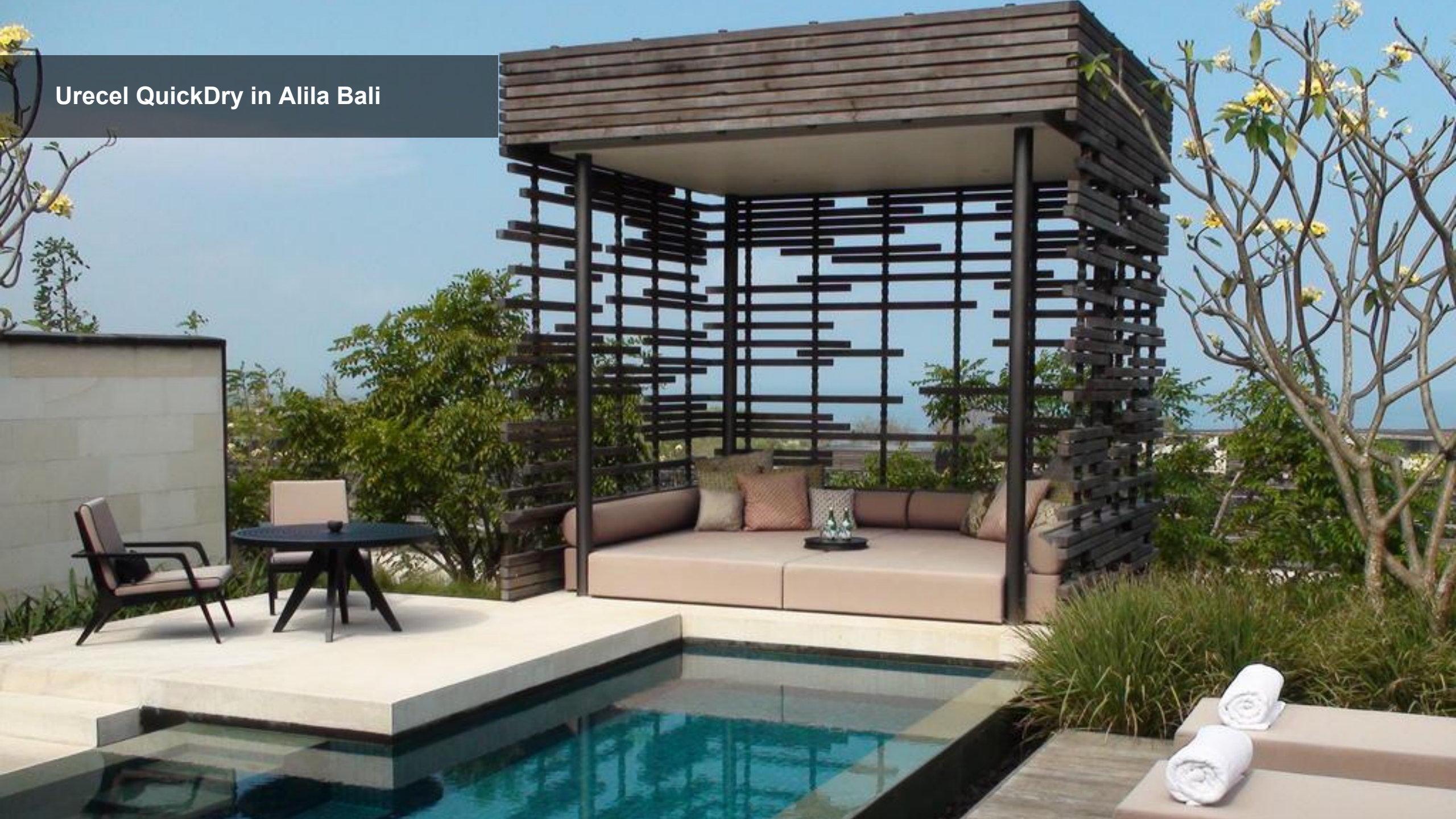

4 Season Langkawi Case Study



quickdryfoam

Four Seasons Resort Langkawi, Malaysia



quickdryfoam Photos of Four Seasons Langkawi
Urecel QuickDry installation 2004-2005
13 years on and still going strong....

Steam and Spa Area



Urecel QuickDry in Prana Interior
Luxury Phinisi Yatch, Bali Indonesia



Urecel QuickDry in Yacht Interior & Exterior – Batavia Marina, Jakarta



CERTIFICATION



Pass IMO 2010 FTP Code - International Code for Application of Fire Test Procedures - Resolution MSC.307 (88) : Annex I - Fire Test Procedures, Part 8 - Test For Upholstered Furniture.



Pass the U.S. Voluntary Physical Performance and Environmental Guidelines for Prime Flexible Polyether Polyurethane Foam for Use in Furniture and Bedding Section 3 and 4.



Pass in California Flammability Technical Bulletin 117 - 2013 Section III



Pass ASTM G21-2012 Standard Practice for Determining Resistance of Synthetic Polymeric Materials to Fungus

QUICKDRY 

www.urecelquickdry.com